

Installation and Aftercare Instructions

Please read completely first before commencing and retain for future reference

⚠ WARNINGS ⚠

- This product must be installed by a qualified fitter or plumber in accordance with and meet the requirements of Water Supply (Water Fittings) Regulations 1999, the Water Supply (Water Fittings) (Scotland) Byelaws 2014 and the Water Supply (Water Fittings) Regulations (Northern Ireland) 2009.
- Prior to installation please ensure that your plumbing system is adequate and that you have sufficient space to complete the installation.
- Prior to installation we recommend a visual inspection of the product to ensure there are no manufacturing defects or damage during transit.

Safety when using Power Tools

- Before drilling into wall, check from hidden electrical cables, wires and water pipes.
- Ensure to wear the correct PPE especially, eye, ear and hand protection.
- Unplug any mains equipment after use and keep electrical equipment away from sources of water at all times.

1 Select appropriate fixing method

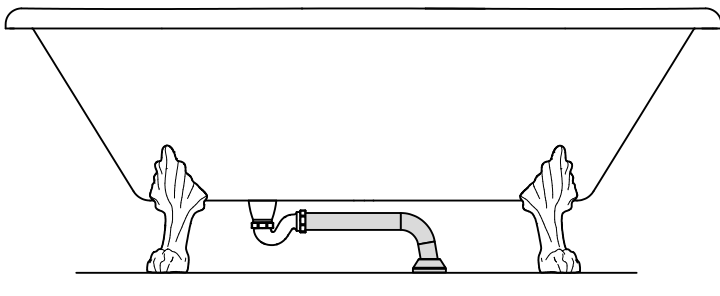

If the waste pipe runs out through the floor, then the long end of the pipe should be connected to the P Trap coming from the bath and the short end should be connected to the waste system.

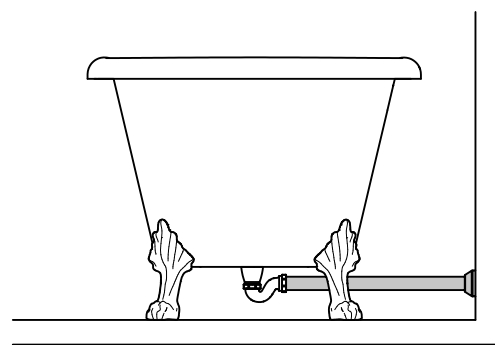

If the waste pipe runs out through the wall, then only the long end of the pipe is required and the short end and the bend of the pipe can be cut off.

1 Selecting appropriate fixing method

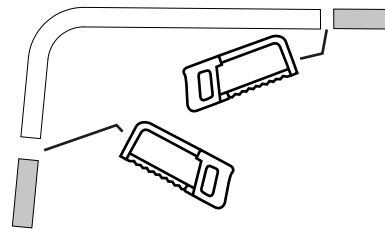
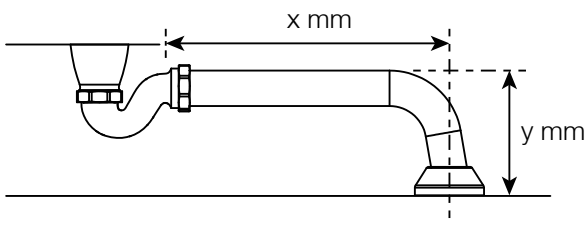

Measure the length of pipe required for the installation and cut down to length with a hacksaw or pipe cutter. Ensure sufficient length is kept to make a seal within the bath tub P trap.

2 Making the connection to the bath tub

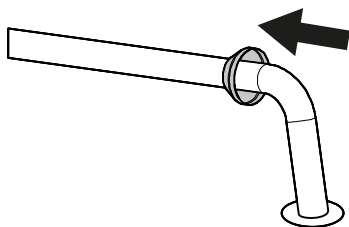

Before connecting the waste pipe to the waste or the bath tub, ensure the covering shroud is on the pipe with the large end facing towards the floor or wall.

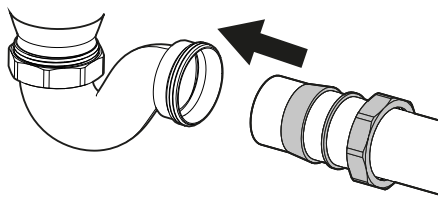

To connect the waste pipe to the bath tub, use the compression fitting and washer from the P-Trap.

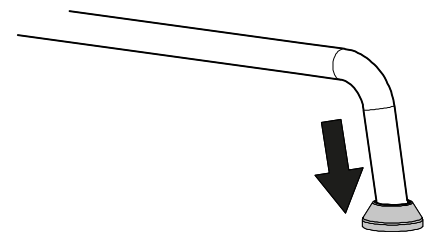

Once the waste pipe is connected the shroud can be secured to the wall or floor (depending upon the installation arrangement) using silicone sealant if required.

Aftercare Instructions



To preserve the finish of your product, clean with a soft cloth and warm soapy water.



Do **NOT** scrub or scour



Do **NOT** use abrasive cleaning agents. Take care using any solvents around the bath, paint stripper and nail polish will damage the bath.