

## SERVICE INTERVALS

Subsequent frequency can be determined with reference to previous test results. Where no significant deviation was recorded the test interval can be made equal to the maximum recorded interval to that point.

Note. Check valve and strainer servicing must be conducted at each test interval.

If the recorded mixed water temperature is greater than  $> 2^{\circ}\text{K}$  from the initial recorded settings or the set point cannot be reached / stabilised further action is required.

It is important to establish that the incoming water supplies still satisfy the initial guidance and also that no additional draw off variation that could affect performance has occurred.

The material selection for this valve has excellent resistance to scale build up and is designed such that there are no serviceable parts beyond items 1 & 2 as described previously. In the very unlikely event that initial performance cannot be achieved, and all external parameters are correct, the unit may require replacement.

## 10-YEAR GUARANTEE

We have complete confidence in this Roper Rhodes product and as such it is offered with a 10-year guarantee against defects in manufacture. The guarantee requires that this product be used in the manner for which it was intended and that it is installed & maintained in accordance with the fitting instructions and local water bylaws. The guarantee covers products in domestic use only.

The guarantee is invalidated should the valve be damaged by water borne debris. Make sure that supply pipes are clear of any debris prior to installation, this is particularly important on new plumbing installations.

In the unlikely event that this product should fail during the guarantee period we will either replace the faulty part or the complete unit as appropriate.

**STORM BAR SHOWER VALVE**  
SV2208

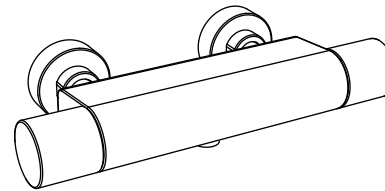

TMV2 / Buildcert Ref No: RRTAV10

**STORM BAR SHOWER VALVE**  
SV2207

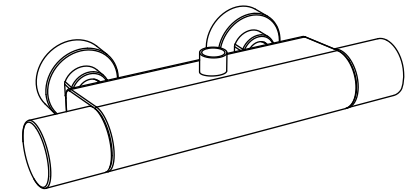

TMV2 / Buildcert Ref No: RRTAV9

**FACTOR BAR SHOWER VALVE**  
SV1308

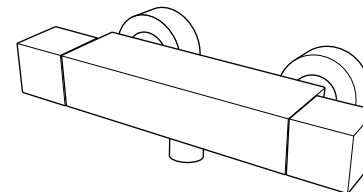

TMV2 / Buildcert Ref No: RRTAV8

**FACTOR BAR SHOWER VALVE**  
SV1307

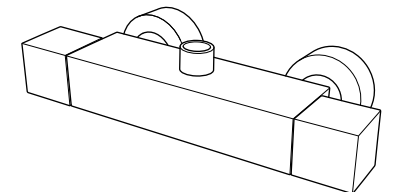

TMV2 / Buildcert Ref No: RRTAV11

## INTRODUCTION

Your bar shower valve is a thermostatic mixer which incorporates a thermo-regulating cartridge to assure users of consistent showering temperatures. The valve has been designed & manufactured to comply with BS EN 1287:1999 & BS EN 1111:1999.

## OPERATING CONDITIONS OF USE

Before installation the operating conditions of use must be checked. The table below contains details of the necessary conditions of operation. If your water supply cannot meet these conditions then the valve cannot be guaranteed to operate as a Type 2 TMV2 certified shower valve. This valve is suitable for use in both low pressure (BS 1287) and high pressure (BS 1111) operating conditions with the following systems:

- Gravity fed Hot & Cold (equal pressures)
- Gravity fed Hot & mains Cold (differential pressure – max ratio 3:1)
- Unvented systems
- Gas combination boiler
- Pumped system

Note: On gravity systems the minimum Vertical distance (Drop) from the underside of the cold water storage tank to the shower valve must be 3 metres.

## CONDITIONS OF USE FOR TYPE 2 VALVES

	HIGH PRESSURE	LOW PRESSURE
Maximum Static Pressure - BAR	10	10
Flow Pressure, Hot & Cold - BAR	0.5 to 5	0.1 to 1
Hot Supply Temperature - °C	55 to 65	55 to 65
Cold Supply Temperature - °C	Equal to or less than 25°C	Equal to or less than 25°C

### NOTE:

Valves operating outside these conditions cannot be guaranteed by the Scheme to operate as Type 2 valves.

### Recommended outlet temperatures

The BuildCert TMV scheme recommends the following set maximum mixed water outlet temperatures for use in all premises:

41°C for showers;

The mixed water temperatures must never exceed 46°C.

The maximum mixed water temperature can be 2°C above the recommended maximum set outlet temperatures.

### NOTE:

46°C is the maximum mixed water temperature from the bath tap. The maximum temperature takes account of the allowable temperature tolerances inherent in thermostatic mixing valves and temperature losses in metal baths.

It is not a safe bathing temperature for adults or children.

The British Burns Association recommends 37 to 37.5°C as a comfortable bathing temperature for children. In premises covered by the Care Standards Act 2000, the maximum mixed water outlet temperature is 43°C.

The thermostatic mixing valve will be installed in such a position that maintenance of the TMV and its valves and the commissioning and testing of the TMV can be undertaken.

The fitting of strainers is recommended as close as is practicable to the water supply inlets of the thermostatic mixing valve.

## TROUBLE-SHOOTING

Problem	Solution
Shower will not run hot enough when first installed	Check for debris Check hot water temperature
Cold water running back through the valve into the hot water system.	Check and clean the check valve cartridges and filters located under the check valves.

If you require further assistance beyond the guide below contact the help line on 01225 303 900

## AFTERCARE INSTRUCTIONS

Whilst this item has a high quality durable finish, it should nevertheless be treated with care. Surfaces should be cleaned using only a soft damp cloth and clean water & dried using a soft cotton cloth. Bath / shower cleaning products, even non-scratch ones could damage the finished surface.

## MAINTENANCE

We advise that the valves, check valves and filters be regularly serviced particularly in hard water areas. The check valves along with the filters are contained in the retaining nut. The water supplies must be isolated remotely from the valve before removal.

TMV2 approved valves shall be tested against the original set temperature results once a year. When testing is due the following performance checks shall be carried out.

1. Measure the mixed water temperature at the outlet.
2. Carry out the cold fail-safe shut off test by isolating the cold water supply to the TMV, wait for 5 seconds if water is still flowing check that the temperature is below 46 degrees C.
3. If there is no significant change to the set outlet temperature (+/- 2°C or less change from the original setting) and the fail safe shut off is functioning, then the valve is working correctly and no further service work is required.

If further maintenance should be required contact Roper Rhodes for details. Please see contact details on the back page of this document.

## COMMISSIONING

It is important that incoming water supplies conform to the requirements specified for pressure and temperature. Assure that supply water conditions satisfy any guidance information for the control of bacteria and that the designation of the supplied valve suits the application. Do not continue commissioning until supplies are correct and stable considering variation caused by other service users.

Use a calibrated thermometer for testing incoming and mixed water.

1. Record temperature of the incoming hot and cold supply.
2. Record temperature of mixed discharge at maximum draw off rate.
3. Record temperature of mixed discharge at minimum draw off rate.
4. Isolate the cold water supply and measure the mixed water temperature as the cold water failure device reacts. This should deviate by no more than + 2°C of the initial maximum set point. Restore the cold supply and measure the stabilised mixed water temperature. This must not deviate by more than + / - 2°C of the initial set recorded result. Record these findings.
5. Record the measuring equipment used for the measurements.

The above records must be retained and updated during the service life of the TMV.

If there is a residual flow during the commissioning or the annual verification (cold water supply isolation test), then this is acceptable providing the temperature of the water seeping from the valve is no more than 20C above the designated maximum mixed water outlet temperature setting of the valve.

Temperature readings should be taken at the normal flow rate after allowing for the system to stabilise.

The sensing part of the thermometer probe must be fully submerged in the water that is to be tested.

Any TMV that has been adjusted or serviced must be re-commissioned and re-tested in accordance with the manufacturers' instructions.

The installation of thermostatic mixing valves must comply with the requirements of the Water Supply (Water Fittings) Regulations 1999.

## IN SERVICE TESTING & MAINTENANCE

The continuing performance of the TMV must be assured. In service validation testing must be conducted at appropriate intervals. The following method is recommended.

First service: Between 6 to 8 weeks after commissioning repeat the initial tests.

That is 1, 2 & 3 as above.

If the stabilised mixed water temperature has changed by > 1°K \*, from the initial recorded setting, check the following before re setting the mixed water temperature.

- a) Check inline filters washers are clear
- b) Check non return valves are clear and operational.
- c) Any isolating valves are fully open.

If the reset temperature is acceptable < 1°K from initial reading repeat the recording routine as 1 to 5 above.

Second service: Between 12 & 15 weeks after commissioning repeat the tests and check measures of the First service. If no significant drift from the initial settings are noted, that is < 1°K record findings accept the tests and expand service interval as indicated on the following page.

If the test results have drifted repeat recovery methods of the first service and conduct the second service again after 6 to 8 weeks.

\*°K = Kelvin, a unit of thermodynamic measurement used to represent a difference of Celsius ( °C ). Kelvin and Celsius units are equivalent.

## VALVE INSTALLATION GUIDELINES AND COMPLIANCE

The valve must be installed so that it is readily accessible for commissioning and maintenance in accordance with the TMV2 scheme. The valve must be installed with isolation valves on both the hot and cold water systems as close as possible to the valve; so as to allow the valve to be commissioned and tested correctly. The valve is fitted with integral check valve cartridges which command the water supply, therefore the thermostatic valve is protected against cross-flow due to unbalanced line pressures as required by the Water Supply (Water Fittings) Regulations 1999.

Most problems associated with the operation of thermostatic shower valves are caused by debris in the new pipe work getting into the thermostat. These problems are easily avoided by thoroughly flushing the pipe work BEFORE the shower valve is fitted.

## WATER SUPPLY - (WATER FITTINGS) REGULATIONS 1999

This valve complies with the requirements of the above regulations and installation should be carried out in strict compliance with them.

## MOUNTING BAR SHOWER VALVES

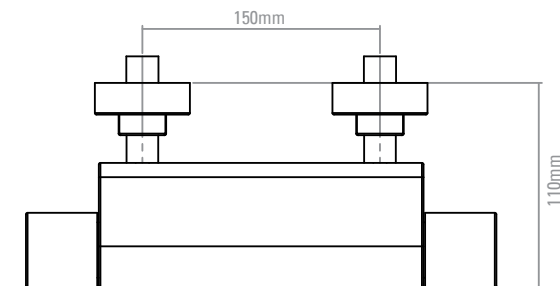

STORM BOTTOM OUTLET BAR VALVE SHOWN

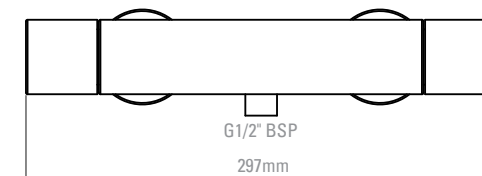

## TEMPERATURE

This valve is factory set to a maximum outlet temperature of 42°C/ 107.6 F

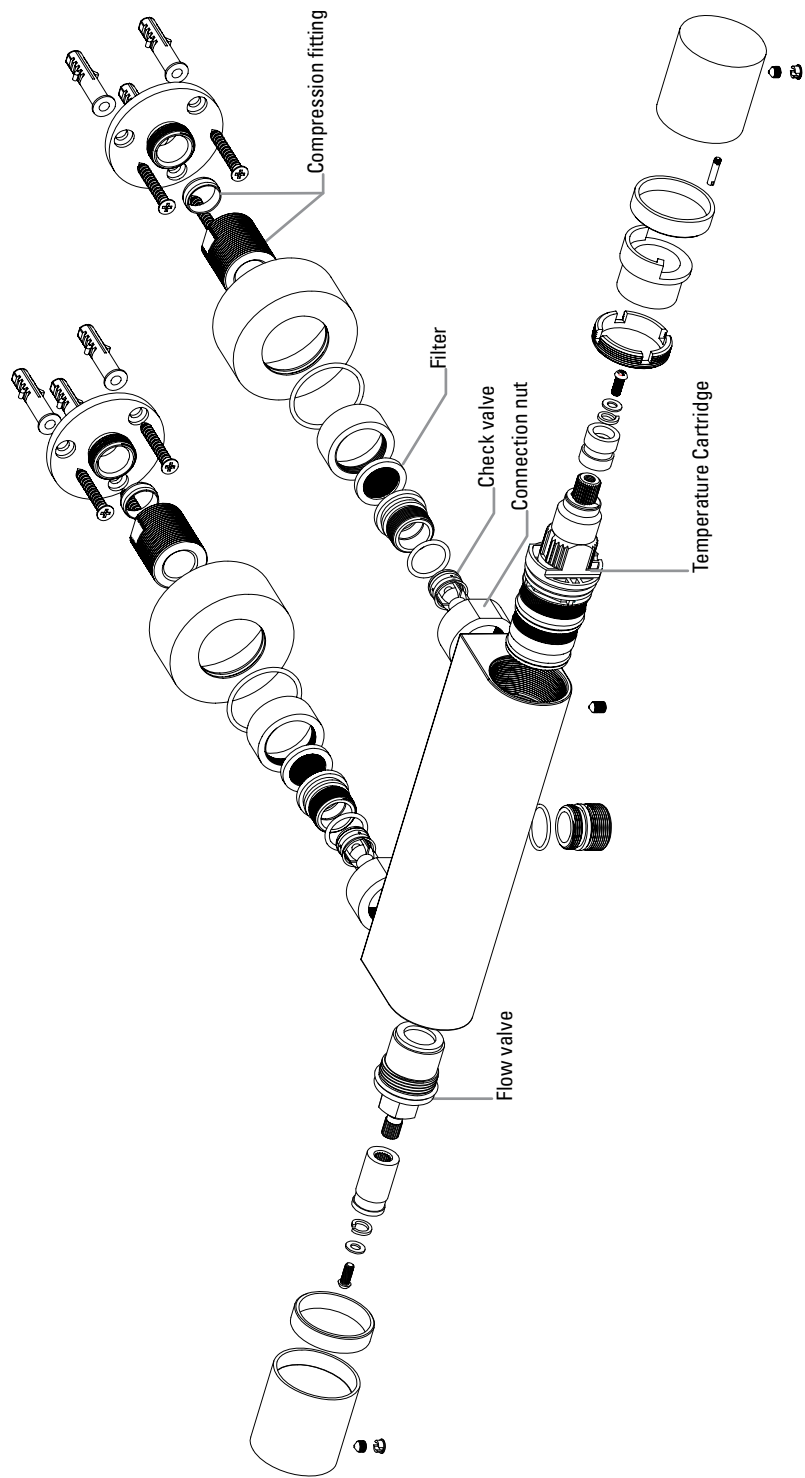

STORM BOTTOM OUTLET BAR VALVE SHOWN

## INSTALLATION

STORM BOTTOM OUTLET BAR VALVE SHOWN

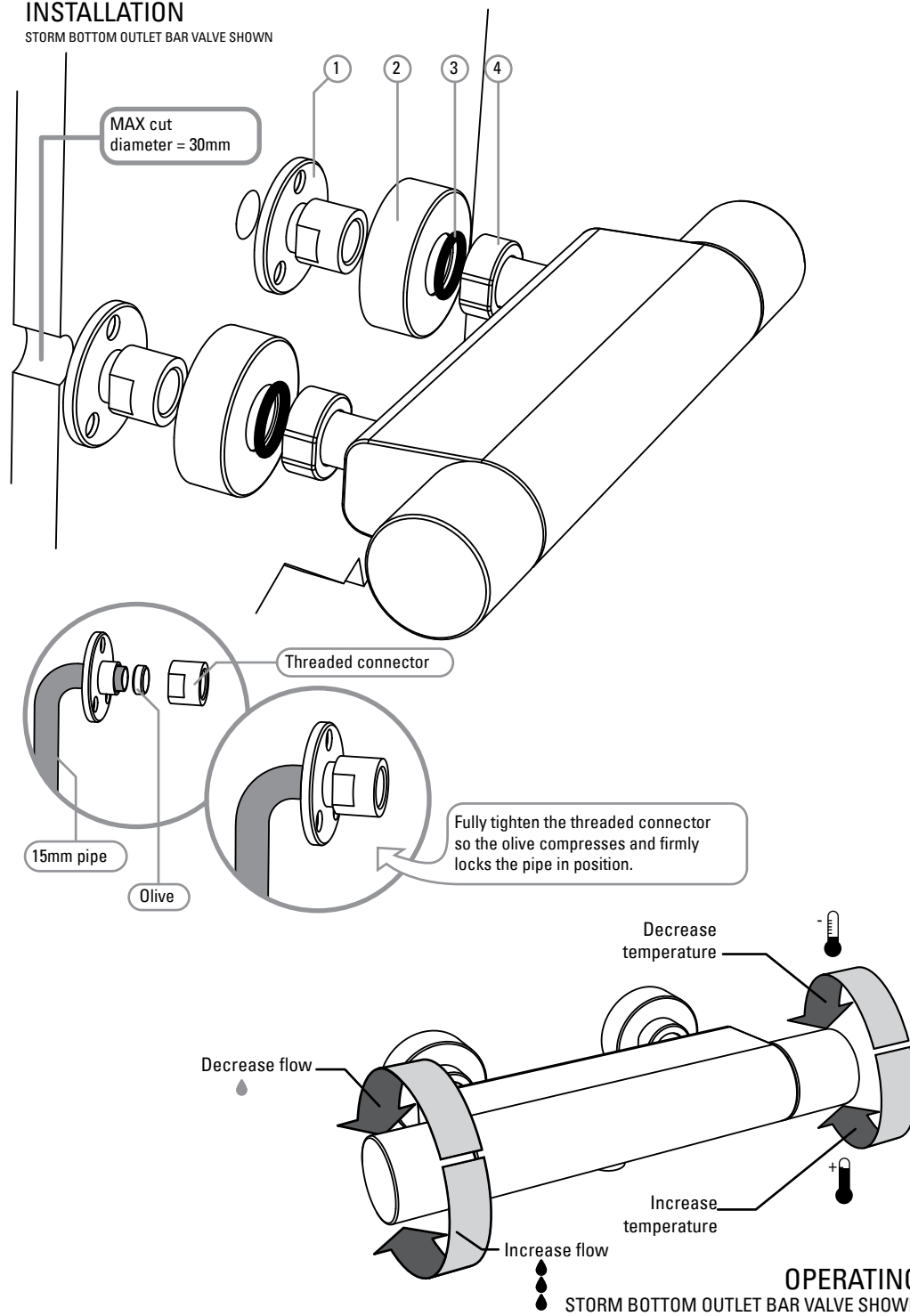

## OPERATING

STORM BOTTOM OUTLET BAR VALVE SHOWN