

TECHNICAL DATA SHEET

TRC500C - Curved 500 Ceramic Basin

Diagrams not to scale
All dimensions in mm
tolerance of +/-5mm

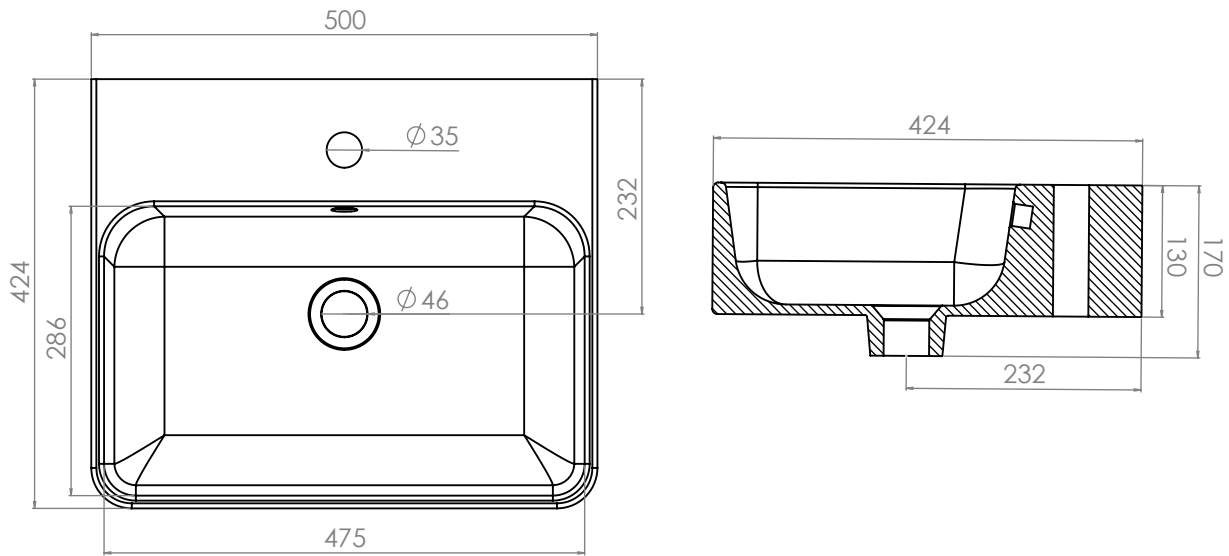

Materials

Basin: Ceramic

*Dimensions are subject to change, customers are advised to measure actual product before commencing installation.

FAQs

Q - What is the maximum water depth of the basin?
A - 78mm up to the overflow.

Q - What is the internal depth?
A - The internal depth is 118mm.

Q - What is the depth of the Tapledge?
A - The Tapledge is 130mm deep.

Q - What is the distance from the Taphole centre to Basin Waste?
A - 125mm

Q - What is the overflow rating?
A - Overflow rating is CL15